

PASSE-PARTOUT

design
SERGIO BELLIN



SitLand®

ALREADY A BEST SELLER FROM THE NAME

Passe-partout is the collection of chairs designed to satisfy the needs of waiting areas and meeting rooms, with utmost comfort and elegance. A product suitable for any need and style.



COMFORTABLE

Passe-partout ensures a high level of comfort thanks to the back and seat pad in flexible polyurethane, crushproof. In particular, Passe-Partout seat pad is ergonomic, in flexible cold injected polyurethane foam, crushproof, with "Comfort-Air" technology.

STYLISH DETAILS

Passe-partout stands out for its details: the arms are integrated in the frame in high-resistance steel tube, featuring in the sled-version, elegant tapered fine weld joints. The arm covers can be matched to the seat upholstery or available in black polyurethane.

TIMELESS ELEGANCE

Passe-partout collection boasts a wide range of valuable upholsteries embellished by a matelassé pattern characterised by handcraft stitching that enhance the silhouette.

MANY NEEDS, ONE COLLECTION

Passe-partout collection is available in the guest version on sled-frame and swivelling meeting version on casters with seat featuring adjustable height or fixed seat, return memory and 4-star base with fixed gliders.

A series of chairs that matched to each other, confer a touch of style and satisfy different needs of use.

MODELS AND DIMENSIONS

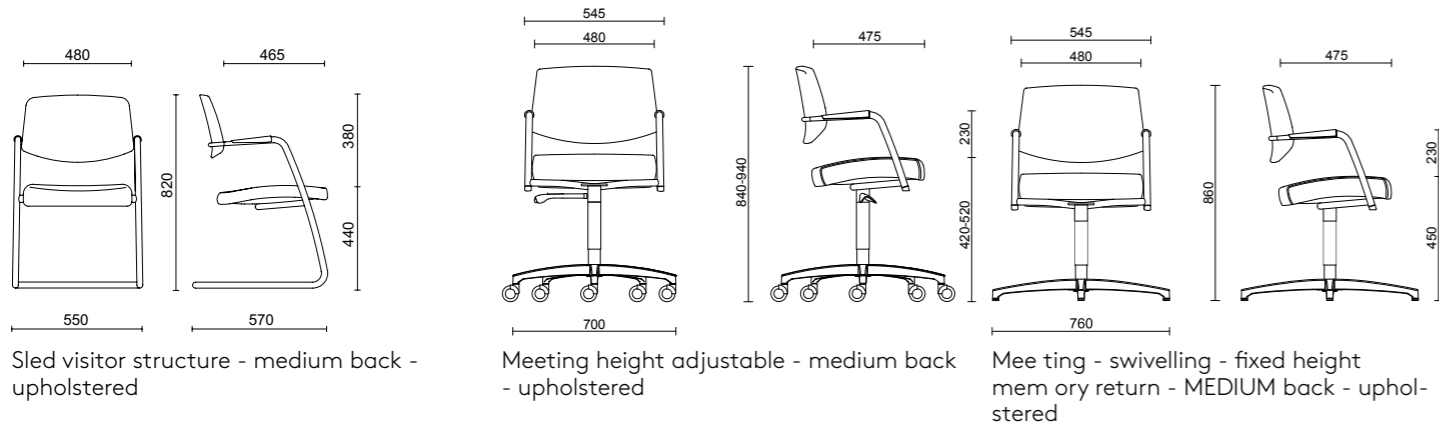

Sled visitor structure - medium back - upholstered

Meeting height adjustable - medium back - upholstered

Meeting - swivelling - fixed height memory return - MEDIUM back - upholstered

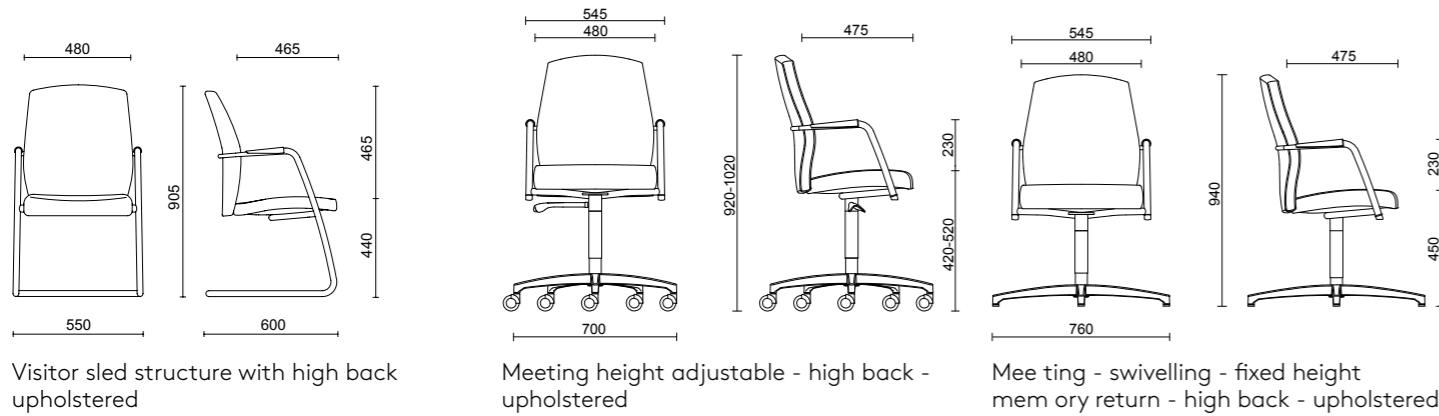

Visitor sled structure with high back upholstered

Meeting height adjustable - high back - upholstered

Meeting - swivelling - fixed height memory return - high back - upholstered

BASES



High resistance 5-star base in black nylon with strengthening steel ring, ø 700 mm.



5-star die-cast aluminium base, polished, ø 700 mm.



5-star die-cast aluminium base, black painted, ø 700 mm.



4 star die-cast aluminium base, 720 mm, polished, ø 760 mm.

CASTERS



Self-braking rubber casters, ø 50 mm for hard floors.



Self-braking casters, ø 50 mm.



Self-braking casters, ø 65 mm for soft floors.



Self-braking rubber casters, ø 65 mm for hard floors.



Hollow free and rubber casters, ø 65 mm for hard floors, black structure.



Hollow free and rubber casters, ø 65 mm for hard floors, chromed structure.

COLOURS, MATERIALS, FINISHING*

STRUCTURE FINISHING



Black painted steel**



Aluminium painted steel**



Chromed steel

UPHOLSTERIES



Fabric AB Xtreme Plus
19 colours



Fabric BN
12 colours



Fabric IP
19 colours

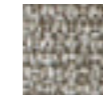

Fabric ME
21 colours



Fabric FA
12 colours



Fabric RA
15 colours



Fabric FE
21 colours



Mesh RR
11 colours

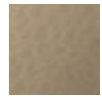

Ecological leather CI-CX
26 colours



Ecological leather N
13 colours

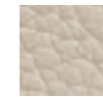

Leather S
13 colours

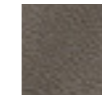

Leather TS
18 colours



Ecological leather N
13 colours

+



Leather S
13 colours

COVER ARM UPHOLSTERIES

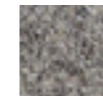

Fabric FE
21 colours



Ecological leather CI-CX
26 colours



Ecological leather N
13 colours

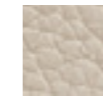

Leather S
13 colours



Leather TS
18 colours

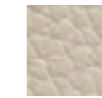

Ecological leather N
13 colours

+



Leather S
13 colours

* Please refer to the Price list in force and to the General sale conditions for the colours and the combinations available for every single product. Colours shown are used for reference only and may look different in reality. Please contact SitLand to receive more information.

** Not available for the following model: meeting, swivelling with fixed height and memory return (medium and high back).

WARRANTY



Passe-partout has 5 years warranty.
For any further detail, please contact
SitLand's customer service at
service@sitland.com

MORE INFORMATION

Please look through our catalogue to
see all the different versions available of
Passe-partout

http://www.sitland.com/sitland_catalogues/sitland_general_catalogue/sitland_general_catalogue.html#p=246

or see our Passe-partout page into our
web site www.sitland.com

UNI EN 1022 CERTIFICATION

Passe-partout comply with the norm UNI
EN 1022.

Tests are performed by



on the model Passe-partout visitor sled
structure with high back upholstered.

PCON.PLANNER



It is possible to configurate our model
Passe-partout by using pCon.planner
program for the design of 2D an 3D
environment.

pCon.planner allows to design working
solutions in a fast and intuitive way,
creating "realistic" images with advanced
features, with a considerable saving of
time and resources.

It is easy to start using pCon.planner:
after downloading the software in the
proper page, it is possible to download
pCon.catalog, the practical online
catalogue of products ready to be set up
according to anyone's need, and then
include the products in the projects.

For more information on the use of pCon.
planner and the access to the products of
the SitLand's catalogues, please contact
com@sitland.com

TILT TOWARD THE FRONT

Seat load: 600 N
Horizontal force: 20 N

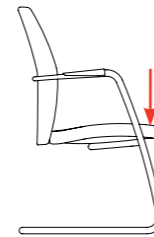

LATERAL TILTING

Seat load: 250 N
Armrest load: 350 N
Horizontal force: 20 N

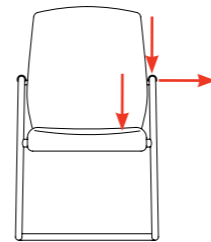

TILT TOWARD THE BACK

Seat load: 600N
Horizontal force: 160 N

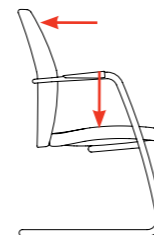

SitLand®

SitLand S.p.A.
Via Cà Silvestre, 52
36024 Nanto - Vicenza - Italy
info@sitland.com - www.sitland.com
Tel. +39 0444 637100

SitLand S.p.A. is certified
UNI EN ISO 9001: 2008
UNI EN ISO 14001: 2004



Follow us on:

