

Soul Air



SitLand®

VERSATILITY BECOMES CHAIR

Soul Air has been designed to be suitable for any kind of environment. Its design and the different possible upholsteries makes this model perfect for the waiting areas as well as for meeting room or workstation chair.

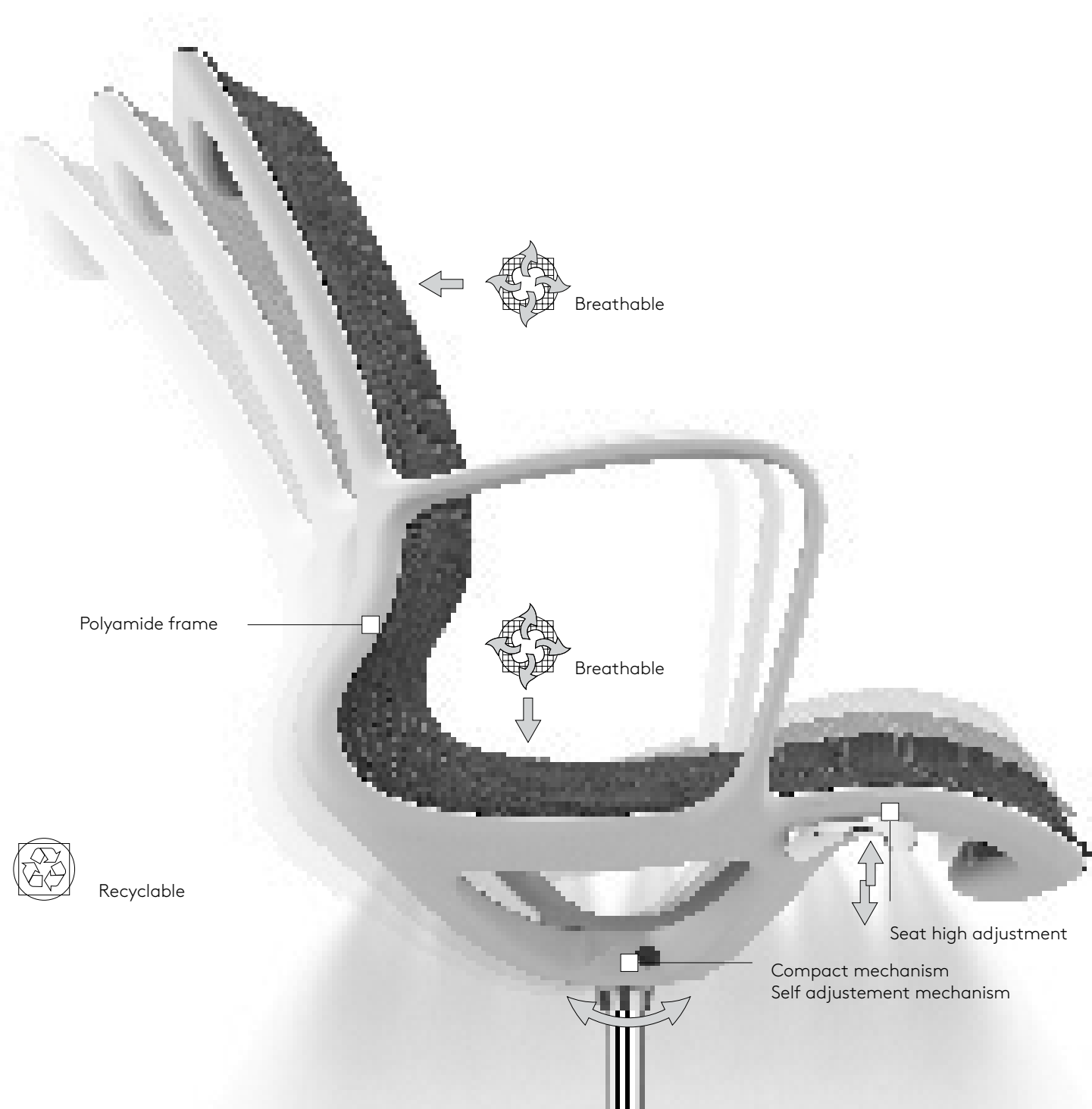

ONE MOULD, ONE CHAIR

The single shell frame of Soul Air completed with arms integrated comes out from a single mould. This model is available both with black and with light grey frame.

AESTHETIC AND COMFORT

The Soul Air back is in breathable mesh and it is perfectly adaptable to the back of any end user.

SELF-ADJUSTING

All the versions of Soul Air are equipped with a tilting self-adjusting mechanism making this chair easy to use by anybody no matter which is the user's weight.

MULTI-FUNCTIONAL COLLECTION

The chair is available with different kind of bases, casters, cover-arms and upholsteries.

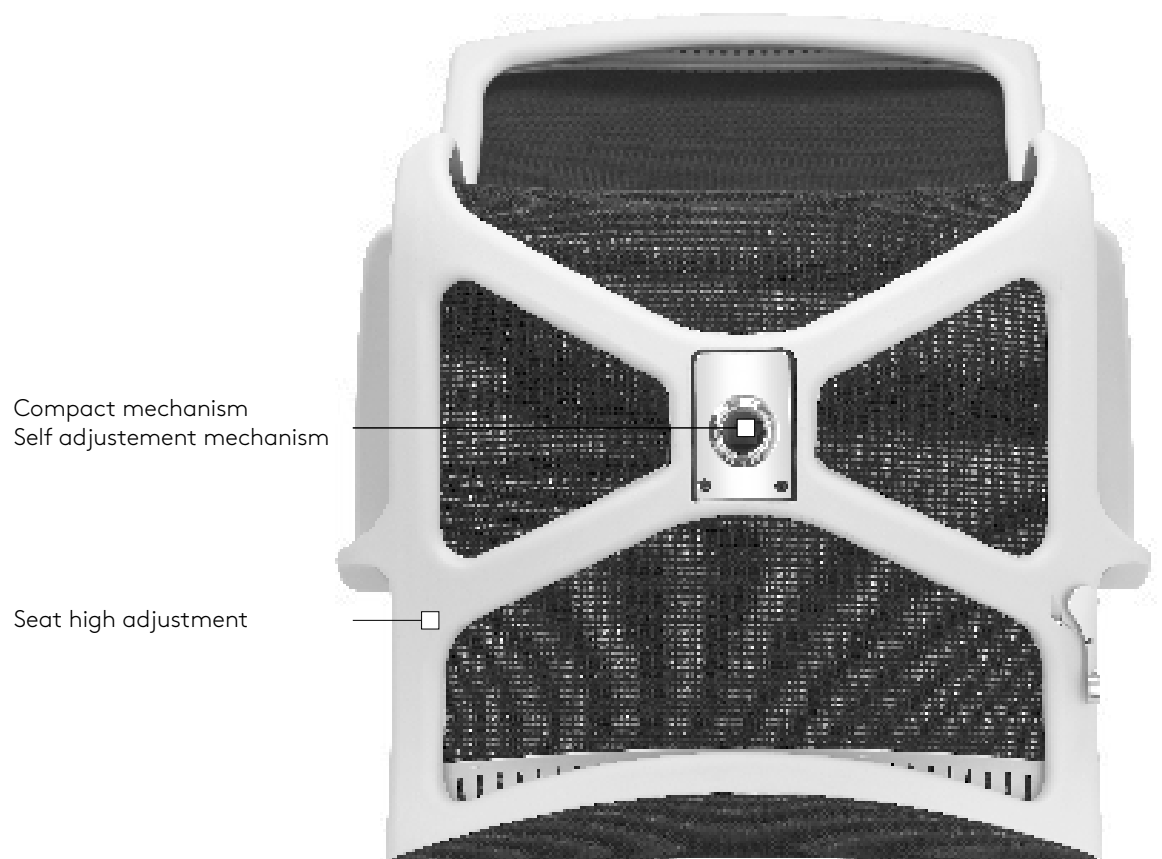

MODELS AND DIMENSIONS

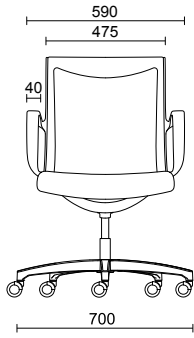

Meeting 5 star base

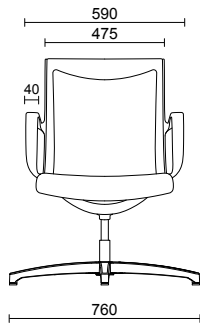

Meeting 4 star base

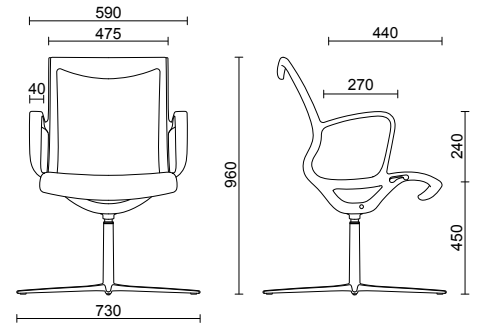

Meeting on 4 star "design" base

BASES



5 star light grey nylon base \varnothing 700 mm, high resistance with reinforcing steel ring.



5 star black nylon base \varnothing 700 mm, high resistance with reinforcing steel ring.



5 star die-cast aluminium base \varnothing 700 mm, polished.



4 star die-cast aluminium base, polished, \varnothing 760 mm.



Elegant and stylish 4 star die-cast aluminium base, polished, with fixed support on felts, \varnothing 730 mm.

CASTERS



Self-braking rubber casters \varnothing 50 mm for hard floors.



Self-braking casters \varnothing 50 mm for soft floors.



Free casters, \varnothing 65 mm for soft floors.



Self-braking casters, \varnothing 65 mm for soft floors.



Self-braking rubber casters, \varnothing 65 mm for hard floors.



Hollow free and rubber casters, \varnothing 65 mm for hard floors, black structure.



Hollow free and rubber casters, \varnothing 65 mm, for hard floors, chromed structure.

COLOURS, MATERIALS, FINISHING *

STRUCTURE COLOUR



Black
polyamide



Light grey
polyamide

MESH UPHOLSTERIES



Mesh
IR
2 colours



Mesh
RR
11 colours



Mesh
SH
5 colours



Mesh
SH
5 colours



Fabric
FE
5 colours

COVER ARMS UPHOLSTERIES



Mesh
SH
5 colours



Mesh
SH
5 colours



Fabric
FE
5 colours

AVAILABLE UPHOLSTERY COMBINATIONS FOR MODEL SOUL AIR IN TECHNICAL MESH SH COMBINED WITH THE WOOL FE



Mesh
SH 01



Fabric
FE 24



Mesh
SH 02



Fabric
FE 03



Mesh
SH 03



Fabric
FE 04



Mesh
SH 04



Fabric
FE 14



Mesh
SH 05



Fabric
FE 12

NOTE: for mesh upholstery cat. SH+FE, there is a support, under the seat, in technical fabric, very strong together with a high resilience foam pad, between the technical sheet and mesh SH, while the rear part of the top of the back is upholstered in fabric FE, matching the colour of the mesh SH.

* Please refer to the Price list in force and to the General sale conditions for the colours and the combinations available for every single product. Colours shown are used for reference only and may look different in reality. Please contact SitLand to receive more information.

PCON.PLANNER



It is possible to configurate our model Soul Air by using pCon.planner program for the design of 2D an 3D environment.

pCon.planner allows to design working solutions in a fast and intuitive way, creating "realistic" images with advanced features, with a considerable saving of time and resources.

It is easy to start using pCon.planner: after downloading the software in the proper page, it is possible to download pCon.catalog, the practical online catalogue of products ready to be set up according to anyone's need, and then include the products in the projects.

For more information on the use of pCon.planner and the access to the products of the SitLand's catalogues, please contact com@sitland.com

WARRANTY



Soul Air has 5 years warranty. For any further detail, please contact SitLand's customer service at service@sitland.com

MORE INFORMATION

Please look through our catalogue to see all the different versions available of Soul Air

http://www.sitland.com/sitland_catalogues/sitland_general_catalogue/sitland_general_catalogue.html#p=180

or see our Soul Air page into our web site www.sitland.com

GREENGUARD CERTIFICATIONS



SOUL AIR has achieved GREENGUARD and GREENGUARD GOLD Certification. GREENGUARD e GREENGUARD Gold are products' certifications released after accurate laboratory tests which assure a low level of chemical emissions of the GREENGUARD tested products in the inner environments. As a matter of fact, in the inner environments, the air is 2 - 5 times more polluted than on the outside and the pollutants comes from products and materials that we use every day. Therefore, the quality of air in the inner spaces is an important issue when people pass the most part of their time in inner environments.

The products certified GREENGUARD ensure a low level of chemical emissions, therefore a better quality of air in those places where they are used. Those chairs which obtained the GREENGUARD Gold certification grant the total absence of chemical emissions, then they are the safest choice for public spaces like schools and healthcare setting. The products certified GREENGUARD contribute to create Leed buildings.

For more information on GREENGUARD, visit the official web site ul.com/gg.

UNI EN 16139 CERTIFICATION

Soul Air complies with the norm UNI EN 16139 which grants resistance, durability and safety for the seating not for domestic use.

The tests performed are:



On the Soul Air with 5 spoke base in black nylon with inner steel reinforcing ring, ø 700 mm, back upholstery mesh SH.

UNI EN 1335 CERTIFICATION

Soul Air complies with the norm UNI EN 1335-3

The work conditions and the protection of the people at work, as far as safety and health are concerned, provide that "the office chairs" are produced according to the ergonomic principles and the functionality requirements contained in the following norms:

- UNI EN 1335-1, dimensions and definitions of the dimensions;
- UNI EN 1335-2, safety requirements;
- UNI EN 1335-3, test procedures for the safety.

The chairs are classified in three different classes according to their specific performance and dimensional characteristics:

- Class A considers the more restrictive dimensional requirements and mostly respect the anthropometric dimensions from 5 to 95% of the population.
- Class B considers the middle requirements among the classes, respecting the minimum requirements requested by D.Lgs. 81/2008.
- Class C considers the minimum requirements.

The tests performed are:



on the Soul Air with 5 spoke base in black nylon with inner steel reinforcing ring, ø 700 mm, back upholstery mesh SH.

FRONT OVERTURNING

Horizontal force: 20 N

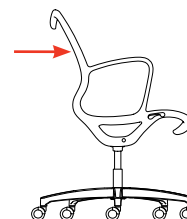

REARWARDS OVERTURNING

Loading discs on the seat: 13
Weight for each disk: 10 kg

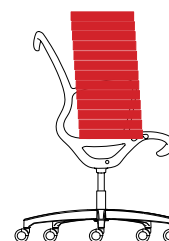

SIDE OVERTURNING

Horizontal force: 20 N

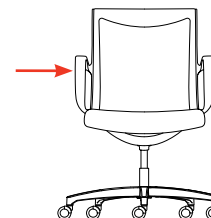

FRONT EDGE OVERTUNING

Horizontal force: 27 kg

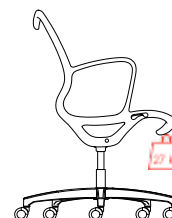

ROLLING RESISTANCE OF UNLOADED CHAIR

Measured resistance of castors: 14,2

Minimum allowed resistance: 12N

Test speed: 50 mm/s

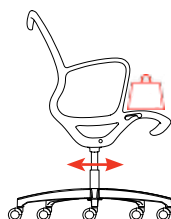

UNI EN 1728 CERTIFICATION

Soul Air complies with the norm UNI EN 1728 which determines the resistance and the duration of the structure for any kind of chairs for adults use.

The tests performed are:



On the Soul Air with 5 spoke base in black nylon with inner steel reinforcing ring, ø 700 mm, back upholstery mesh SH.

ARM DOWNWARDS STATIC LOAD TEST

Load: 750 N
Number of cycles: 5

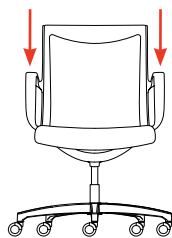

SEAT IMPACT TEST

Load: 25 kg
Height of drop: 240 mm
Number of drops: 10

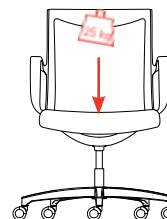

SEAT AND BACK FATIGUE TEST FOR RECLINING CHAIRS

Seat load: 930 N
Back load: 350 N
Number of cycles: 100.000

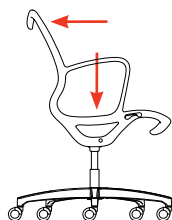

BACK IMPACT TEST

Angle: 38°
Mass of impactor: 6,5 kg
Number of cycles: 10

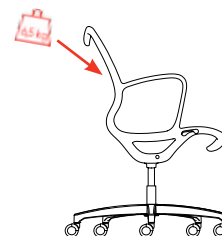

SEAT AND BACK STATIC LOAD TEST

Seat load: 1.500 N
Back load: 570 N
Number of cycles: 10

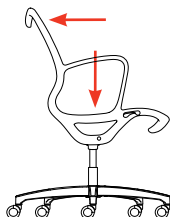

SEAT FRONT EDGE DURABILITY TEST

Load: 800 N
Number of cycles: 50.000

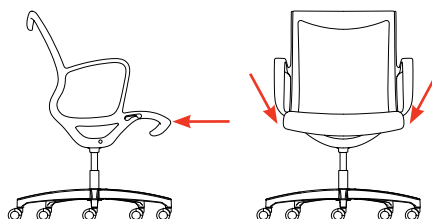

ARM REST IMPACT TEST

Angle: 38°
Mass of impactor: 6,5 kg
Number of cycles: 10

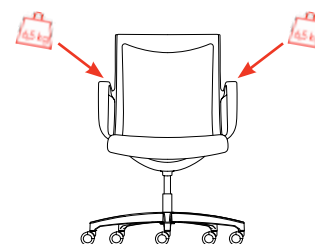

TEST SEAT FRONT EDGE STATIC LOAD

Seat load: 1.300 N
Number of cycles: 10

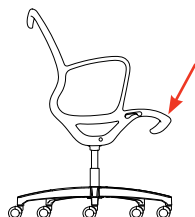

ARM FATIGUE TEST

Load on arm rest: 400 N
Number of cycles: 30.000

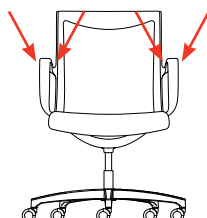

ARM SIDEWAYS STATIC LOAD TEST

Load: 400 N
Number of cycles: 10

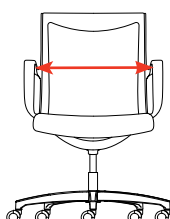

SitLand®

SitLand S.p.A.
Via Cà Silvestre, 52
36024 Nanto - Vicenza - Italy
info@sitland.com - www.sitland.com
Tel. +39 0444 637100



SitLand is certified by
UNI EN ISO 9001: 2008
UNI EN ISO 14001: 2004

Follow us

