

UseMe



SitLand®



Ufficio

UseMe è un comodo supporto da affiancare alla scrivania ma anche una postazione di lavoro informale.

Office

UseMe is a comfortable support to complement the desk but also a location of informal employment.



Formazione

Utile nelle aule formative dove lo spazio è ridotto ed è richiesta versatilità.

Training

Useful in training classrooms where space is limited and requiring flexibility.



Hotel

Nelle hall degli hotel come piano di appoggio durante le attese o nelle camere come postazione di lavoro.

Hotel

In the lobby of the hotels, as a support surface during waiting periods or in the rooms as a workstation.



Casa

A casa come tavolino di servizio in cucina o nelle camerette ma anche nella zona giorno per leggere una rivista o lavorare comodamente in divano.

Home

At home as a service table in the kitchen or in the children's rooms but also in the living room to read a magazine or work comfortably in a sofa.



Aeroporto

Nelle aree lounge degli aeroporti per usare il proprio tablet o pc prima di un volo.

Airport

In the lounge areas of airports to use your tablet or PC before a flight.



Caffè

Come tavolino per una pausa veloce.

Coffee

As a side table for a quick break.

PREMI / AWARDS



reddot award 2016
winner



UseMe

design
SCAGNELLATO - BERTOLINI - FERRARESE

wherever.

Versatile e funzionale, UseMe è la soluzione per ogni esigenza: dall'ufficio alla casa, dagli hotel agli aeroporti, dalle sale formative ai bar.

Versatile and functional, UseMe is the solution for every need: from office to home, from hotels to airports, from training center to bars.







UseMe















Top in MDF verniciato / Top in laquered MDF



Legno di betulla multistrato
Multilayered birch wood



Effetto ruggine
Rust effect



Bianco texturizzato
Textured white

Top in laminato / Top in laminated panel



Legno naturale 1611
Natural wood 1611



Grigio scuro 871
Dark gray 871



Grigio chiaro 475
Light gray 475



Nero 421
Nero Fenix NTM®
Black 421
Black Fenix NTM®



Bianco 411
Bianco Fenix NTM®
White 411
White Fenix NTM®

Colori scocca, supporto, maniglia e sfera / Shell, support, handle and sphere colours





Top in MDF verniciato / Top in laquered MDF



Legno di betulla multistrato
Multilayered birch wood



Effetto ruggine
Rust effect



Bianco texturizzato
Textured white

Top in laminato / Top in laminated panel



Legno naturale 1611
Natural wood 1611



Grigio scuro 871
Dark gray 871



Grigio chiaro 475
Light gray 475



Nero 421
Nero Fenix NTM®
Black 421
Black Fenix NTM®



Bianco 411
Bianco Fenix NTM®
White 411
White Fenix NTM®

Colori scocca, supporto, maniglia e sfera / Shell, support, handle and sphere colours



Pad System

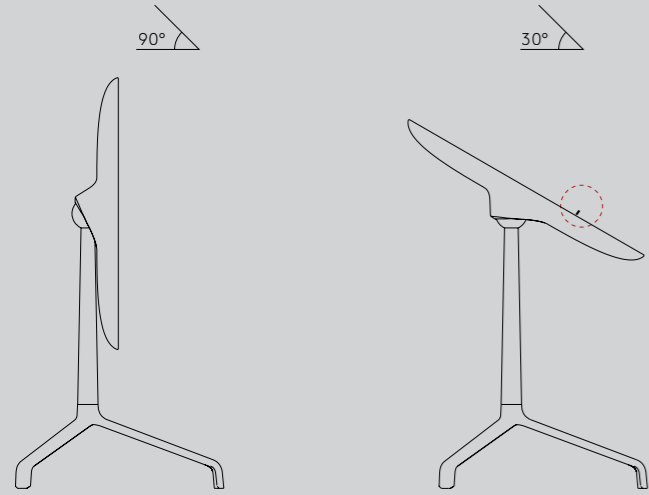

Il piano di UseMe è reclinabile in tre posizioni: 0°, 30° e 90°.

UseMe può essere aperto a 0° quando serve e facilmente richiuso a 90° per essere riposto in un spazio limitato: 10 tavoli in 1,50 m di profondità.

Nella versione con Pad System inclinando di 30° il piano si attiva automaticamente un sistema di appoggio che permette di usare tablet, smartphone e qualsiasi altro oggetto. L'inclinazione a 30° del tavolino consente una posizione corretta ed ergonomica diminuendo i riflessi e permettendo una posizione meno inclinata in avanti per un'attività visiva più confortevole.

The plan of UseMe can be reclined in three positions: 0°, 30° and 90°.

UseMe can be opened to 0° when needed and easily closed again at 90° to be stored in a limited space: 10 tables in 1.50 m deep.

In the version with Pad System, inclining the top of UseMe, a support system comes out automatically permitting the use of tablets, smartphones, books, etc. The inclination of 30° of the table allows a better vision and a more comfortable and correct working position.

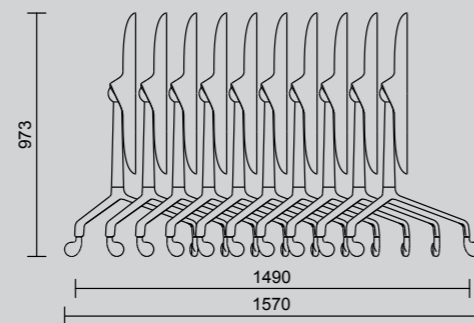
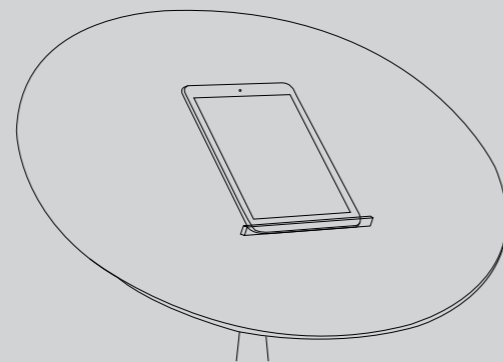

Scocca rotonda, senza ruote / Round shell, without casters

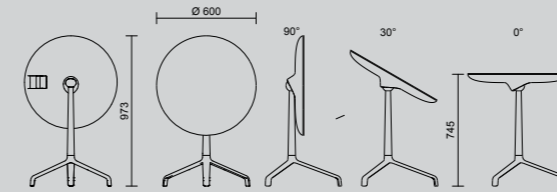

Scocca rotonda, con ruote / Round shell, with casters

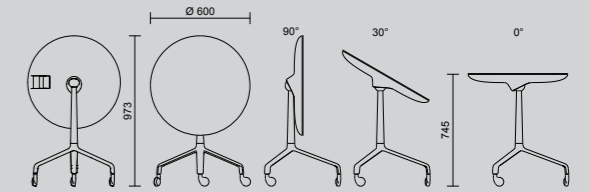

Scocca rettangolare, senza ruote / Rectangular shell, without casters

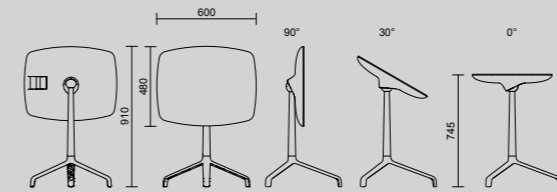

Scocca rettangolare, con ruote / Rectangular shell, with casters

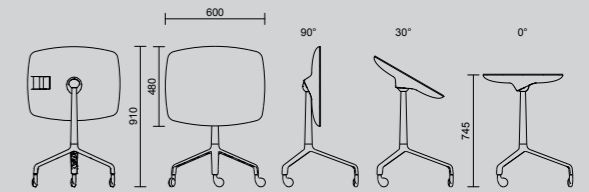

SitLand[®]
www.sitland.com

SitLand spa

Via Cà Silvestre, 52
36024 Nanto - Vicenza - Italy
Tel + 39 0444 637100
Fax + 39 0444 638407
info@sitland.com
service@sitland.com
www.sitland.com

follow us on

